

DEMATECH

PREISANGEBOT / CENOVÁ NABÍDKA

Maschinenart Stirnradgetriebemotor, dreistufig /

Druh stroje: čelní převodovka třístupňová

Marke und Typ / Značka a typ: NORD SK 63-100 I/40
BRE 40

Hersteller / Výrobce: Getriebebau NORD



DEMATECH s.r.o.
Kubelikova 1224/42
CZ - 130 00 Praha 3
IČO: 28072332
DIČ: CZ28072332
dematech.praha@gmail.com
www.dematech.cz
Betrieb/Lager/Provoz/Sklad:
Korespondenzadresse / koresp.adresa :
Jinin 78
CZ - 386 01 Strakonice



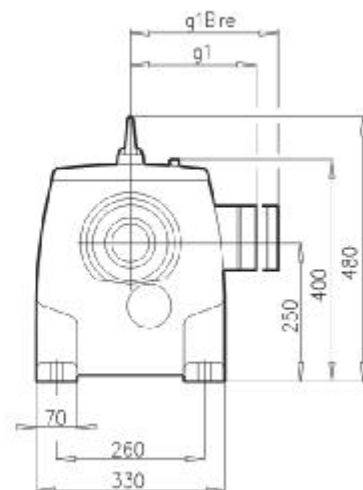
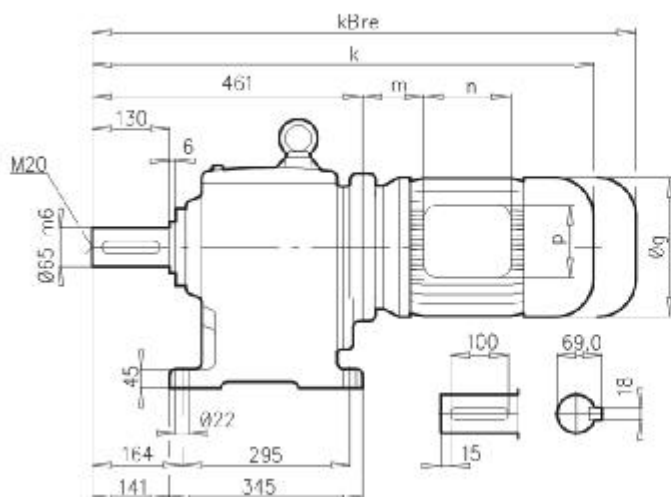

NORD SK 63-100 I/40 BRE 40 EL.Motor 100I/40 BRE 1440 u/min 3 kW

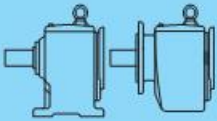

DEMATECH

P_1 [kW]	n_2 [min ⁻¹]	M_2 [Nm]	f_B	i_{ges}	F_R [kN]	F_A [kN]	$F_{R VL}$ [kN]	$F_{A VL}$ [kN]		 kg	 mm
2,20	5,4	3891	0,9	265,32	13,7	24,2	24,0	45,0	SK 63 - 100L/4	147	B79
	6,7	3136	1,2	214,10	16,4	24,1	25,6	45,0			
	8,0	2626	1,4	180,57	17,7	23,8	26,5	45,0			
	9,9	2122	1,7	145,71	18,7	23,3	27,2	45,0			
	13	1616	2,3	107,89	19,5	22,3	27,7	45,0			
	17	1236	2,5	87,06	19,9	21,4	28,0	45,0			
	19	1106	3,0	77,46	20,0	20,9	28,1	44,6			
	23	913	3,2	62,87	20,1	20,1	28,2	42,6			

	M_{2max} [Nm]
SK 63	3700

	i_{ges}	n_2 n1= 1400 min ⁻¹ [min ⁻¹]	M_{2max} fB=1 [Nm]	W $f_B \geq 1$			IEC $f_B \Rightarrow$  B2 - B38								
				n1= 1400 min ⁻¹ [kW]	n1= 930 min ⁻¹ [kW]	n1= 700 min ⁻¹ [kW]	IEC 90	IEC 100	IEC 112	IEC 132	IEC 160	IEC 180			
SK 63	372,21	3,8	3200	1,27	0,84	0,64	•								
	300,34	4,7	3200	1,57	1,04	0,79									
	265,32	5,3	3640	2,02	1,33	1,01		•	•						
	214,10	6,5	3640	2,48	1,64	1,24		•	•						
W	180,57	7,8	3660	2,99	1,97	1,49		•	•	•					



DEMATECH

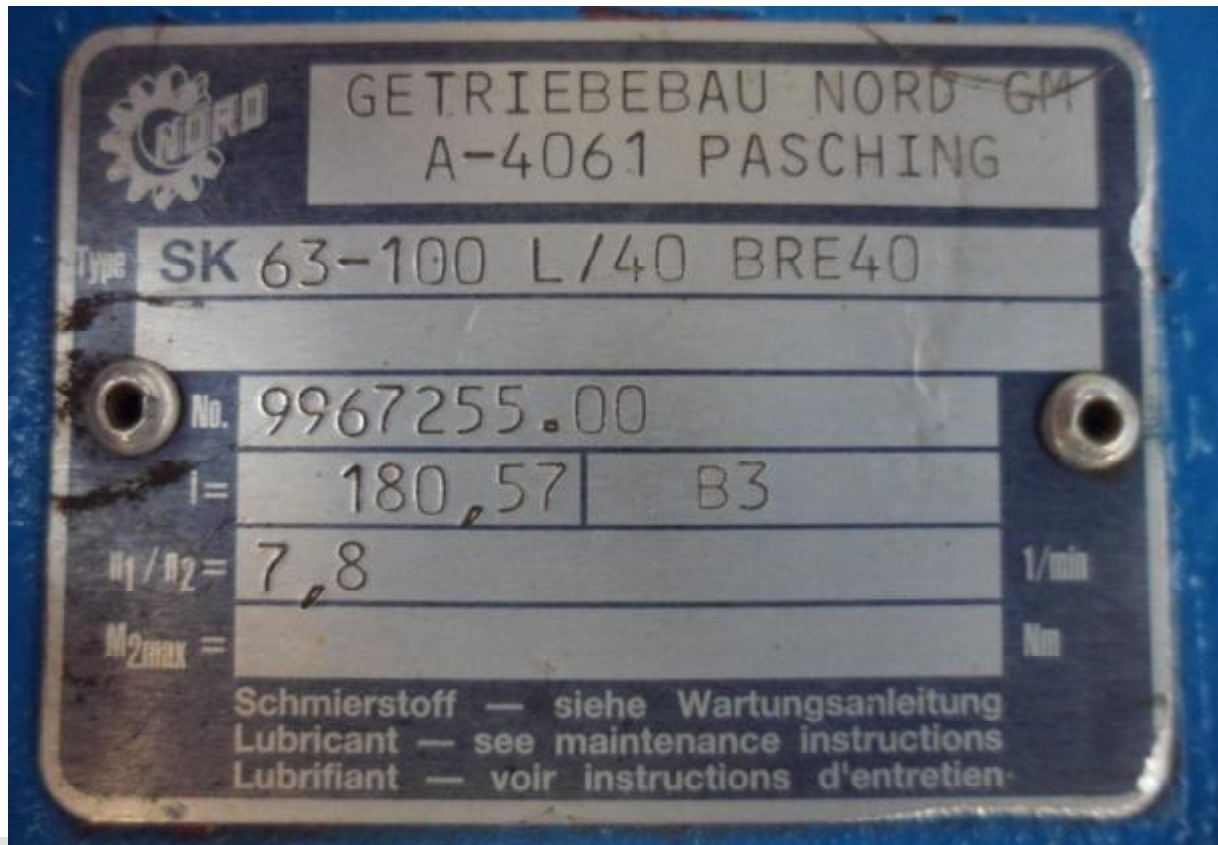

(Změny a chyby v technických datech, popisech a cenách a rovněž meziprodej vyhrazeny !)
(Änderungen und Irrtümer in den technischen Daten, Angaben und Preisen sowie Zwischenverkauf vorbehalten!)