

# DEMATECH

## PREISANGEBOT / CENOVÁ NABÍDKA

Maschinenart Stirnradgetriebemotor, zweistufig /

Druh stroje: čelní převodovka dvoustupňová

Marke und Typ / Značka a typ: C 40 2P P 100

Hersteller / Výrobce: Bonfiglioli Italy

Bau Jahr / rok výroby 1999

Preis 500 EUR EXW Strakonice (ohne MWSt)

DEMATECH s.r.o.  
Kubelikova 1224/42  
CZ - 130 00 Praha 3  
IČO: 28072332  
DIČ: CZ28072332  
[dematech.praha@gmail.com](mailto:dematech.praha@gmail.com)  
[www.dematech.cz](http://www.dematech.cz)  
Betrieb/Lager/Provoz/Sklad:  
Korespondenzadresse / koresp.adresa :  
Jinin 78  
CZ - 386 01 Strakonice





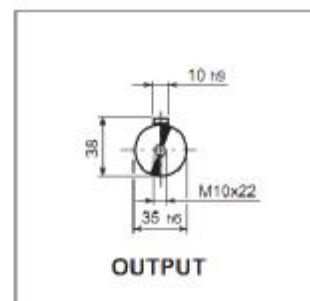
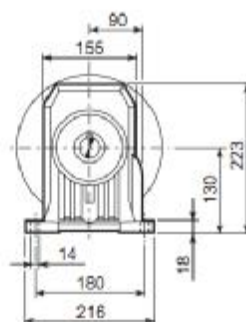
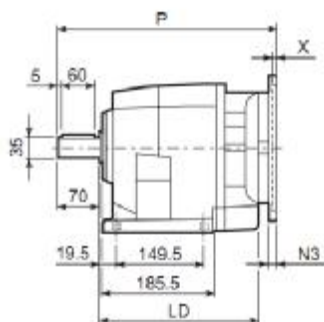

C40 2P P 100,  
EL.Motor BN 112M4 1420 u/min 4 kW  
i - 15,8  
n2 90 u/min

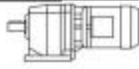

# DEMATECH

## 4 kW

$n_2$ min <sup>-1</sup>	$M_2$ Nm	S	i	$R_{n2}$ N			 IEC 	
88	413	1.1	15.8	4740	C412 15.8 S3 M3LC4	122	C40 15.8 P100BN112M4	123



# DEMATECH

**Preis 500 EUR EXW Strakonice (ohne MWSt)**

(Změny a chyby v technických datech, popisech a cenách a rovněž meziprodej vyhrazeny !)  
(Änderungen und Irrtümer in den technischen Daten, Angaben und Preisen sowie Zwischenverkauf vorbehalten!)